

KM-320M_H

MODULAR CRESCENT CUBER

SLIM-LINE SERIES

Item # _____

Project: _____

Qty: _____

*AutoCad available on KCL

KM-320M_H

4/08

Item # 13170

CUBER DIMENSIONS

W x D x H

KM-320M_H

22 x 27^{3/8} x 30^{5/16}



DB-130



DB-200

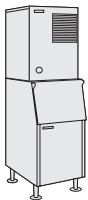

B-300



B-500

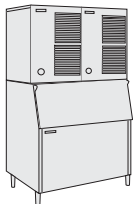

B-700

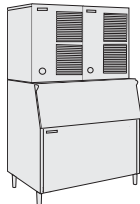

B-800

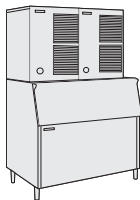

B-900

Also available on Large Bins:
 B-1150SS
 B-1300SS
 B-1500SS
 B-1650SS





KM-320MAH

Air-Cooled
 Shown on an optional
 B-300

KM-320MWH

Water-Cooled

- Up to 352 lbs. of ice production per 24 hours
- Durable stainless steel exterior
- Individual crescent cube
- Protected by *HoshiGuard* Antimicrobial Agent **HOSHIGUARD**
- CycleSaver® Design 
- EverCheck® alert system 
- Stainless steel evaporator
- Removable air filters (Air-cooled model only)
- R-404A Refrigerant
- Complies with California Energy Commission guidelines (CEC)

* The KM-320MAH is ENERGY STAR certified.

Warranty

Valid in United States, Canada, Puerto Rico, & U.S. Territories. Contact factory for warranty in other countries.

Three Year - Parts & Labor on entire machine.

Five Year - Parts & Labor on: Evaporator.

Five Year - Parts on: Compressor, air-cooled condenser coil.



© HOSHIZAKI AMERICA, INC.

618 Hwy. 74 S., Peachtree City, GA 30269

TEL 1-800-438-6087

FAX 1-800-345-1325

www.hoshizaki.com



KM-320M_H MODULAR CRESCENT CUBER

DIMENSIONS
W x D x H
KM-320M_H
22 x 27^{3/8} x 30^{5/16}

- Air-cooled
- Water-cooled

AIR-COOLED

Water Temp° F.	50°	70°	90°
Air Temp° F.	70°	311	287
80°	315	293	265
90°	311	278	251

WATER-COOLED

Water Temp° F.	50°	70°	90°
Air Temp° F.	70°	348	324
80°	349	342	309
90°	348	337	308

UTILITY CONSUMPTION

Model Number	Ice Production Per Cycle		KWH per 100 LBS. 90/70	Potable Water Gal. per 100 lbs. 90/70	Condenser Water Gal. per 100 lbs. 90/70
	Lbs.	Cubes			
KM-320MAH	7.2	360	6.9	18.4	N/A
KM-320MWH	7.2	360	5.2	16.8	157

SPECIFICATIONS

Model Number	Condenser	Amperage	Min. Circuit Ampacity	Shipping Weight
KM-320MAH	Air-Cooled	9.7	20	153 lbs.
KM-320MWH	Water-Cooled	8.2	20	153 lbs.

STORAGE BINS

Model Number	Application Capacity	ARI-Rated Capacity
B-300	300 lbs.	260 lbs.
B-500	500 lbs.	360 lbs.
B-700	700 lbs.	550 lbs.
B-800	800 lbs.	600 lbs.
B-900	900 lbs.	660 lbs.
B-1150	1150 lbs.	N/A
B-1300	1275 lbs.	N/A
B-1500	1490 lbs.	N/A
B-1650	1605 lbs.	N/A

ELECTRICAL & PLUMBING/KM-320M_H

- 115V/60/1
- 20 amp Max Fuse/HACR Breaker Size
- 1/2" FPT Water Inlet
- 3/4" FPT drain
- 3/8" FPT condenser water outlet (Water-Cooled Only)
- 1/2" FPT condenser water inlet (Water-Cooled Only)

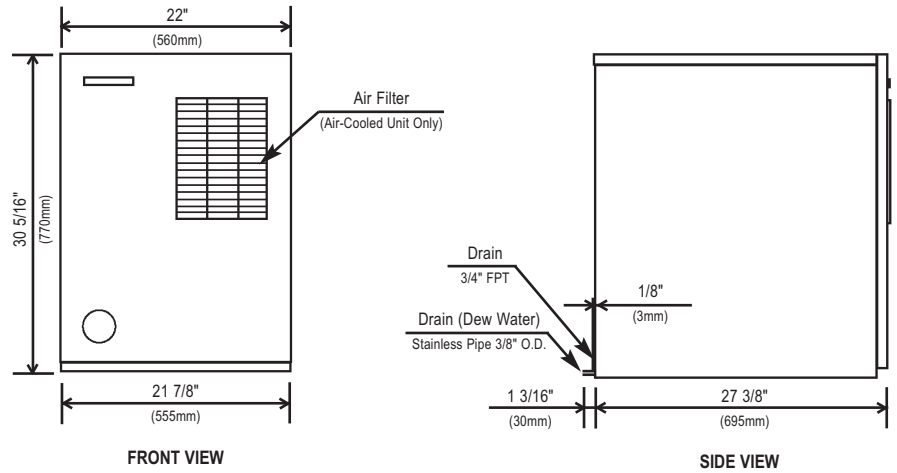

FRONT VIEW

SIDE VIEW

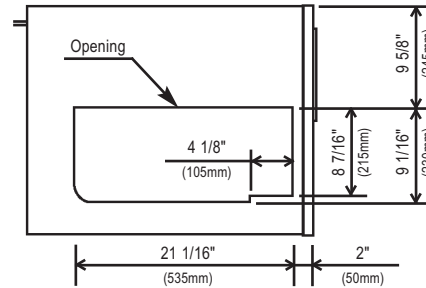

ICE DROP ZONE

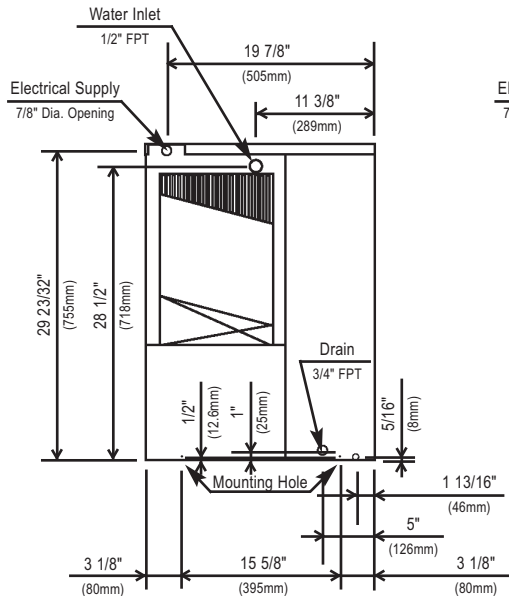

AIR-COOLED UNIT

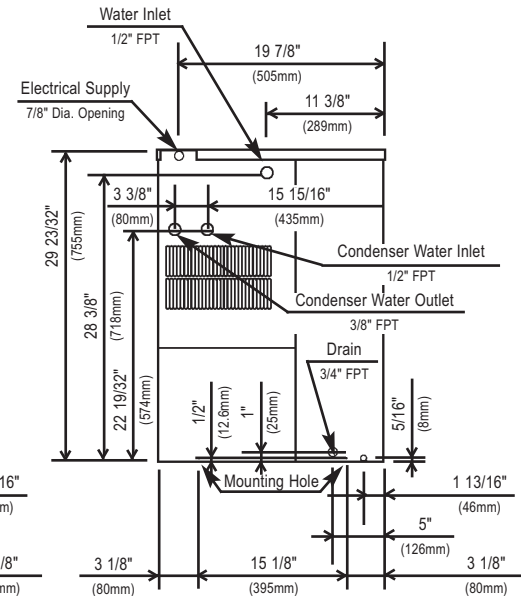

WATER-COOLED UNIT

OPERATING LIMITS

- Ambient Temp Range 45 - 100°F
- Water Temp Range 45 - 90°F
- Water Pressure 10 - 113psig
- Voltage Range 104 - 127V

SERVICE

- Panels easily removed and all components accessible for service.
- Removable/cleanable air filters (Air-Cooled model only)



© HOSHIZAKI AMERICA, INC.

618 Hwy. 74 S., Peachtree City, GA 30269

TEL 1-800-438-6087

FAX 1-800-345-1325

www.hoshizaki.com

Printed in U.S.A.

