

KM-2000/2400S_H3

3 PHASE STACKABLE ICE CUBER

Item # _____

Project: _____

Qty: _____

*AutoCad available on KCL

KM-2000/2400S_H3

4/08

Item # 13128

CUBER DIMENSIONS

W x D x H

KM-2000/2400S_H3
48 x 27^{3/8} x 36^{7/16}

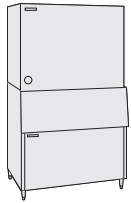

B-800

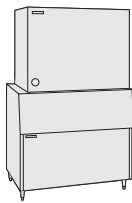

B-900

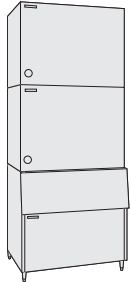

B-800

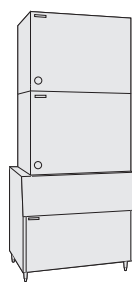

B-900

Also available on Large Bins:
B-1150SS
B-1300SS
B-1500SS
B-1650SS



KM-2000SWH3

Water-Cooled 3 Phase
Shown on an optional
B-900

KM-2000SRH3

Remote Air-Cooled 3 Phase

KM-2400SRH3

Remote Air-Cooled 3 Phase



KM-2000S_H3

- Up to 1891 lbs. of ice production per 24 hours
- Stackable for 3782 lbs. per 24 hour ice production in the same floor space

KM-2400SRH3

- Up to 2321 lbs. of ice production per 24 hours
- Stackable for 4642 lbs. per 24 hour ice production in the same floor space

KM-2000S_H3 & KM-2400SRH3

- Durable stainless steel exterior
- Protected by *HoshiGuard* Antimicrobial Agent 
- CycleSaver® design 
- EverCheck® alert system 
- Individual crescent cube
- Stainless steel evaporator
- R-404A Refrigerant
- Complies with California Energy Commission guidelines (CEC)

* The KM-2000SRH3 is ENERGY STAR certified.



Warranty

Valid in United States, Canada, Puerto Rico, & U.S. Territories. Contact factory for warranty in other countries.

Three Year - Parts & Labor on entire machine.

Five Year - Parts & Labor on: Evaporator.

Five Year - Parts on: Compressor, air-cooled condenser coil.



KM-2000/2400S_H3 3 PHASE STACKABLE ICE CUBER

DIMENSIONS
W x D x H
KM-2000S_H3
48 x 27^{3/8} x 36^{7/16}
KM-2400SRH3
48 x 27^{3/8} x 36^{7/16}

STACKABLE ICE CUBER

- Water-cooled 3 phase / Remote Air-cooled 3 phase
- Remote Air-cooled 3 phase

KM-2000 WATER - COOLED 3 PHASE

Water Temp ° F.	50°	70°	90°
Air Temp ° F.			
70°	1891	1883	1817
80°	1885	1873	1776
90°	1883	1864	1740

KM-2000 REMOTE AIR - COOLED 3 PHASE

Water Temp ° F.	50°	70°	90°
Air Temp ° F.			
70°	1865	1831	1746
80°	1839	1786	1679
90°	1831	1748	1649

KM-2400 REMOTE AIR - COOLED 3 PHASE

Water Temp ° F.	50°	70°	90°
Air Temp ° F.			
70°	2301	2307	2172
80°	2305	2315	2100
90°	2307	2321	1980

UTILITY CONSUMPTION

Model Number	Ice Production Per Cycle Lbs. Cubes	KWH per 100 LBS.	Potable Water Gal. per 100 lbs.	Condenser Water Gal. per 100 lbs.
KM-2000SWH3	46.3 2160	3.8	20.7	77
KM-2000SRH3	46.3 2160	4.4	20.0	N/A
KM-2400SRH3	44 2160	5.1	21.9	N/A

SPECIFICATIONS

Model Number	Condenser	Amperage	Min. Circuit Ampacity	Shipping Weight
KM-2000SWH3	Water-Cooled	9.5	20	400 lbs.
KM-2000SRH3	Remote Air-Cooled	12.0	20	400 lbs.
KM-2400SRH3	Remote Air-Cooled	17	30	425 lbs.

STORAGE BINS

Model Number	Application Capacity	ARI-Rated Capacity
B-800	800 lbs.	600 lbs.
B-900	900 lbs.	660 lbs.
B-1150	1150 lbs.	N/A
B-1300	1275 lbs.	N/A
B-1500	1490 lbs.	N/A
B-1650	1605 lbs.	N/A

ELECTRICAL & PLUMBING/KM-2000/2400S_H3

- 208 - 230V/60/3
- 20 amp Max Fuse (30 amp Max Fuse - KM-2400)
- 1/2" FPT copper or equivalent independent potable water supply
- 3/4" FPT independent drain connection



© HOSHIZAKI AMERICA, INC.

618 Hwy. 74 S., Peachtree City, GA 30269

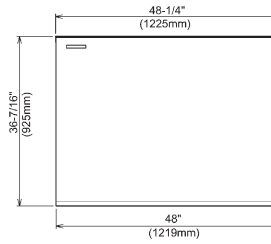

FRONT VIEW - KM-2000/2400

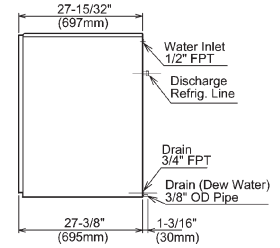

SIDE VIEW - KM-2000/2400

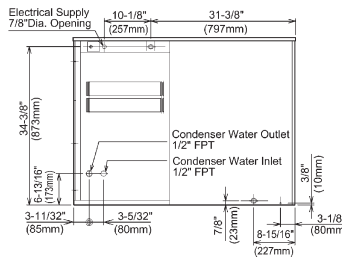

KM-2000SWH3 WATER-COOLED UNIT

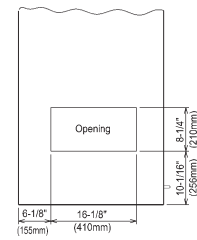

ICE DROP ZONE - KM-2000/2400

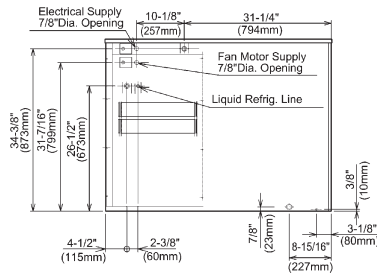

KM-2000SRH3 REMOTE AIR-COOLED UNIT

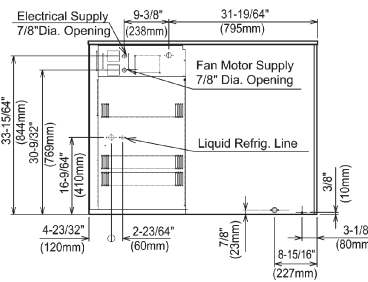

KM-2400SRH3 REMOTE AIR-COOLED UNIT

URC-20F Remote Condenser (Sold Separately)
For Use with KM2000SRH3

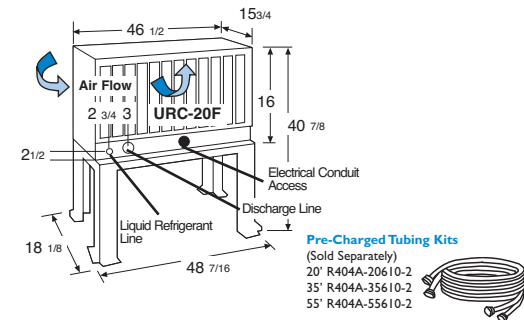

Pre-Charged Tubing Kits (Sold Separately)
20' R404A-20610-2
35' R404A-35610-2
55' R404A-55610-2

URC-24F Remote Condenser (Sold Separately)
For Use with KM-2400SRH3

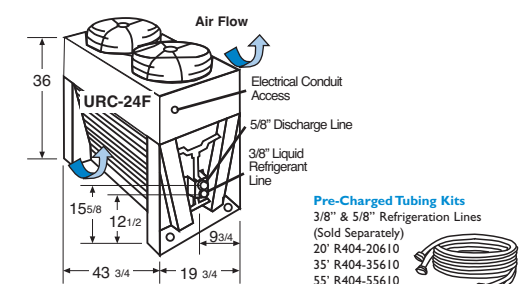

Pre-Charged Tubing Kits (Sold Separately)
3/8" & 5/8" Refrigeration Lines
20' R404-20610
35' R404-35610
55' R404-55610

OPERATING LIMITS

- Ambient Temp Range 45 - 100°F
- Water Temp Range 45 - 90°F
- Water Pressure 10 - 113psig
- Voltage Range 187 - 253V

SERVICE

- Panels easily removed and all components accessible for service.
- Removable/cleanable air filters (Air-cooled model only)

TEL 1-800-438-6087

FAX 1-800-345-1325

www.hoshizaki.com

Printed in U.S.A.

