

KM-1900S_H(3)

STACKABLE ICE CUBER

Item # _____

Project: _____

Qty: _____

*AutoCad available on KCL

KM-1900S_H(3)

I/13

Item # 13234

CUBER DIMENSIONS

W x D x H

KM-1900S_H(3)
48 x 27^{3/8} x 36^{7/16}

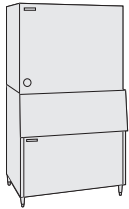

B-800

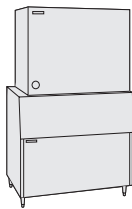

B-900

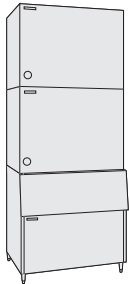

B-800

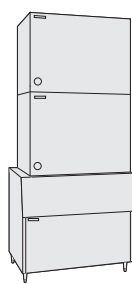

B-900

Also available on Large Bins:
B-1150SS
B-1300SS
B-1500SS
B-1650SS

KM CUBE DIMENSIONS

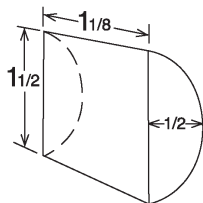

KM-1900SAH

Air-Cooled 1 Phase
Shown on an optional
B-900

KM-1900SAH3

Air-Cooled 3 Phase

KM-1900SWH

Water-Cooled 1 Phase

KM-1900SWH3

Water-Cooled 3 Phase



KM-1900SRH

Remote Air-Cooled 1 Phase

KM-1900SRH3

Remote Air-Cooled 3 Phase



- Up to 1903 lbs. of ice production per 24 hours
 - Durable stainless steel exterior
 - Protected by H-GUARD Plus Antimicrobial Agent 
 - CycleSaver® design 
 - EverCheck® alert system 
 - Individual crescent cube
 - Stainless steel evaporator
 - Stackable for 3930 lbs. per 24 hour ice production in the same floor space
 - Removable air filters (Air-cooled model only)
 - R-404A Refrigerant
- * The KM-1900SAH, KM-1900SAH3, and KM-1900SRH are ENERGY STAR qualified.



ISO 9001-5:2008

Warranty

Valid in United States, Canada, Puerto Rico, & U.S. Territories. Contact factory for warranty in other countries.

Three Year - Parts & Labor on entire machine.

Five Year - Parts & Labor on: Evaporator.

Five Year - Parts on: Compressor, air-cooled condenser coil.



HOSHIZAKI

DIMENSIONS W x D x H KM-1900S_H(3) 48 x 27^{3/8} x 36^{7/16}

STACKABLE ICE CUBER

- Air-cooled 1 phase / Air-cooled 3 phase
- Water-cooled 1 phase / Water-cooled 3 phase
- Remote Air-cooled 1 phase / Remote Air-cooled 3 phase

KM-1900S_H(3) STACKABLE ICE CUBER

AIR - COOLED 1 PHASE / 3 PHASE

Water Temp ° F.	50°	70°	90°
Air Temp ° F. 70°	1867 / 1859	1777 / 1763	1638 / 1633
Air Temp ° F. 80°	1798 / 1786	1659 / 1636	1511 / 1507
Air Temp ° F. 90°	1777 / 1763	1560 / 1530	1413 / 1398

WATER - COOLED 1 PHASE / 3 PHASE

Water Temp ° F.	50°	70°	90°
Air Temp ° F. 70°	1876 / 1825	1868 / 1822	1734 / 1693
Air Temp ° F. 80°	1870 / 1823	1858 / 1818	1655 / 1619
Air Temp ° F. 90°	1868 / 1822	1850 / 1814	1673 / 1642

REMOTE AIR - COOLED 1 PHASE / 3 PHASE

Water Temp ° F.	50°	70°	90°
Air Temp ° F. 70°	1857 / 1903	1793 / 1829	1636 / 1678
Air Temp ° F. 80°	1809 / 1847	1710 / 1731	1514 / 1552
Air Temp ° F. 90°	1793 / 1829	1640 / 1650	1457 / 1480

UTILITY CONSUMPTION

Model Number	Ice Production Per Cycle		KWH per 100 LBS.	Potable Water Gal. per 100 lbs.	Condenser Water Gal. per 100 lbs.
	Lbs.	Cubes			
KM-1900SAH	45.3	2160	4.1	18.8	N/A
KM-1900SAH3	45.5	2160	4.1	17.0	N/A
KM-1900SWH	47.0	2160	3.1	18.8	99
KM-1900SWH3	45.4	2160	3.3	18.8	99
KM-1900SRH	46.0	2160	4.09	20.0	N/A
KM-1900SRH3	46.8	2160	4.04	20.9	N/A

SPECIFICATIONS

Model Number	Condenser	Amperage	Min. Circuit Ampacity	Shipping Weight
KM-1900SAH	Air-Cooled	14.4	30	415 lbs.
KM-1900SAH3	Air-Cooled	8.6	20	415 lbs.
KM-1900SWH	Water-Cooled	12.5	30	415 lbs.
KM-1900SWH3	Water-Cooled	8.4	20	415 lbs.
KM-1900SRH	Remote Air-Cooled	14.9	30	415 lbs.
KM-1900SRH3	Remote Air-Cooled	11.0	20	415 lbs.

STORAGE BINS

Model Number	Application Capacity	ARI-Rated Capacity
B-800	800 lbs.	600 lbs.
B-900	900 lbs.	660 lbs.
B-1150	1150 lbs.	N/A
B-1300	1275 lbs.	N/A
B-1500	1490 lbs.	N/A
B-1650	1605 lbs.	N/A

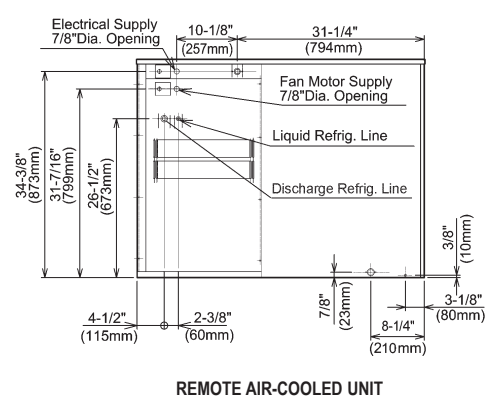
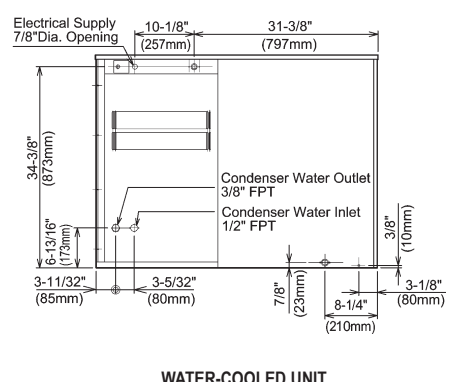
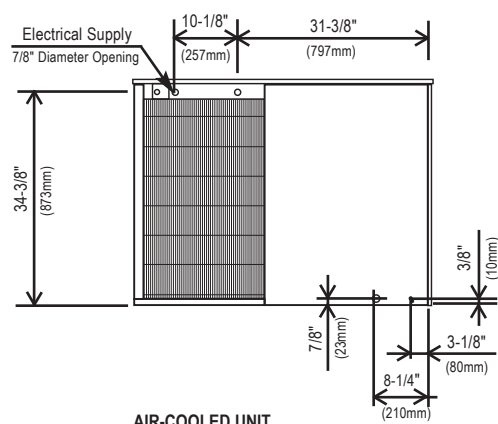
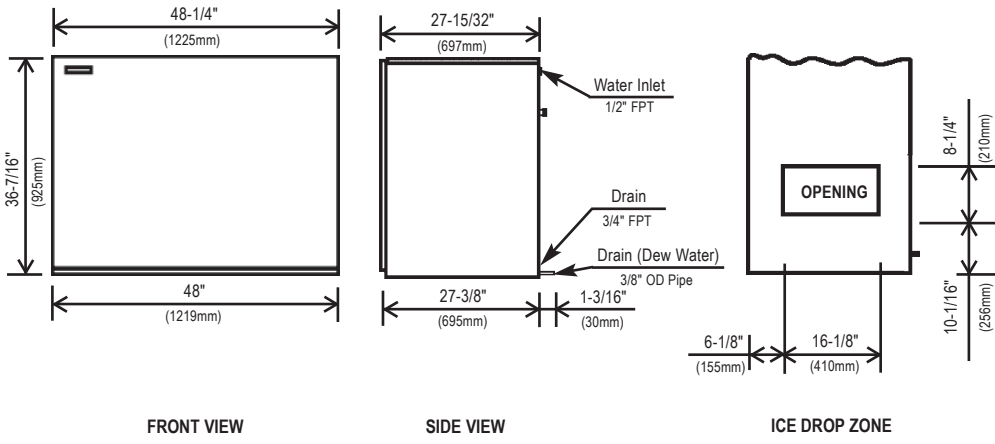

URC-22F Remote Condenser (Sold Separately)
For Use with KM-1900SRH / KM-1900SRH3

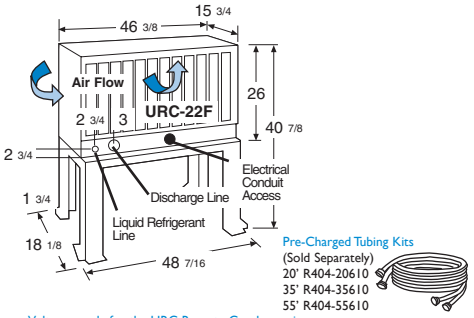

Voltage supply for the URC Remote Condenser is supplied from the Ice Maker. No additional circuit is required.

ELECTRICAL & PLUMBING/KM-1900S_H(3)

- KM-1900SAH / SVWH / SRH**
- 208 - 230V/60/1ø (3 wire with neutral for 115V)
 - 30 amp Max Fuse/HACR Breaker Size
- KM-1900SAH3 / SVWH3 / SRH3**
- 208 - 230V/60/3ø
 - 20 amp Max Fuse/HACR Breaker Size
 - 1/2" OD copper or equivalent independent potable water supply
 - 3/4" FPT independent drain connection

OPERATING LIMITS

- Ambient Temp Range 45 - 100°F
- Water Temp Range 45 - 90°F
- Water Pressure 10 - 113psig
- Voltage Range 187 - 253V

SERVICE

- Panels easily removed and all components accessible for service.
- Removable/cleanable air filters (Air-cooled model only)

CONDENSING UNIT

- Voltage Range 104 - 127V
- Ambient Temp Range -20 - 122°F



© HOSHIZAKI AMERICA, INC.

618 Hwy. 74 S., Peachtree City, GA 30269

TEL 1-800-438-6087

FAX 1-800-345-1325

www.hoshizaki.com

Printed in U.S.A.

